

Model 9910-D30, D30AP-A, D30GRGI, & D30-B-GRGI

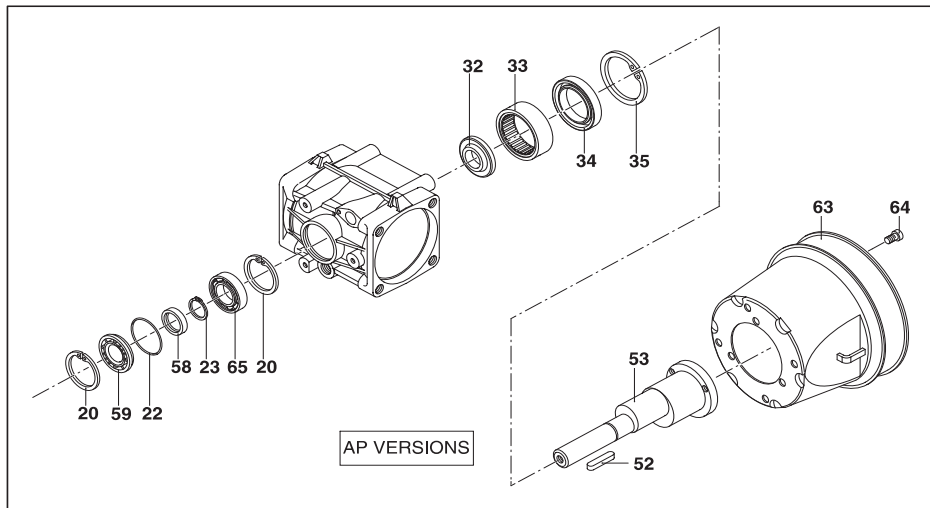
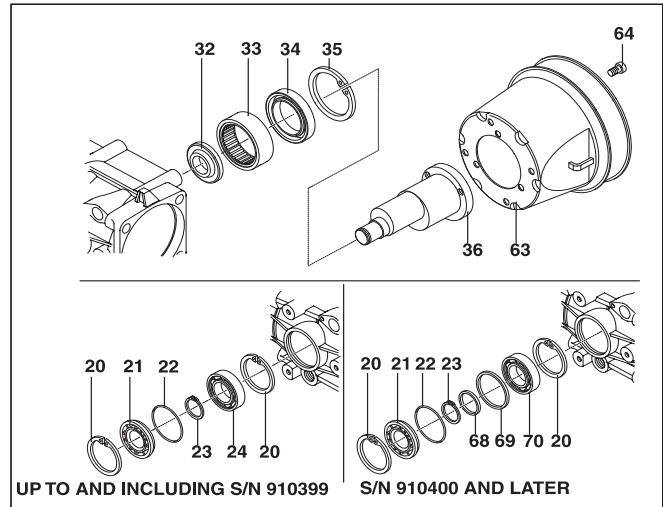
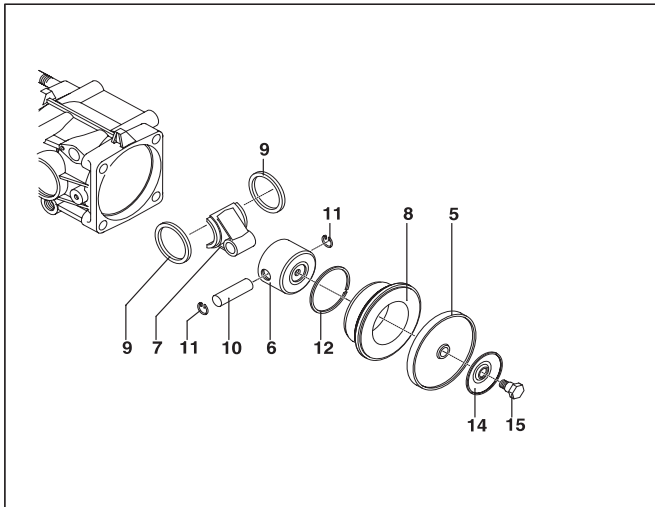
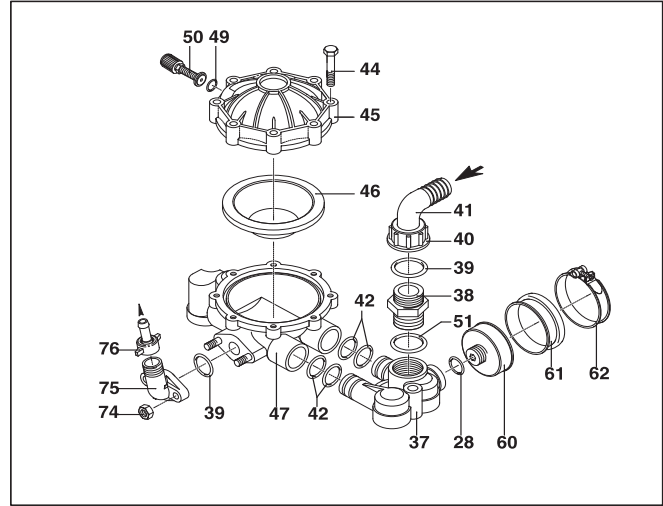
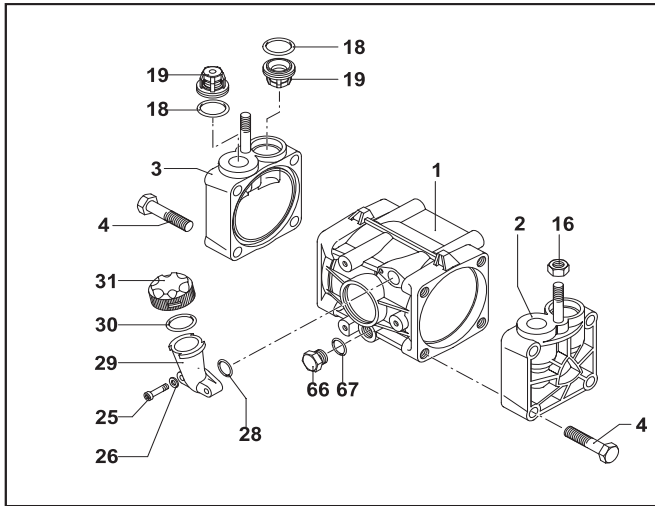

Figure 28

NOTE: When ordering parts, give QUANTITY, PART NUMBER, DESCRIPTION, and COMPLETE MODEL NUMBER. Reference numbers are used ONLY to identify parts in the drawing and are NOT to be used as order numbers.

Model 9910-D30, D30AP-A, D30GRGI, & D30-B-GRGI

Ref. No.	Part Number	Description	Qty.
1	9910-629011	Pump Body w/bolts	1
2	9910-620101	Right Head Assembly (DX)	1
3	9910-620102	Left Head Assembly (SX)	1
4	9910-621430	M12 x 55 Bolt	8
5 ¹	9910-620085	Diaphragm, Desmopan (Std.)	2
5	9910-620080	Diaphragm, Buna-N (Opt.)	2
6	9910-620120	Piston	2
7	9910-620140	Connecting Rod	2
8	9910-620110	Sleeve	2
9	9910-580470	Retainer Ring	2
10	9910-380300	Connecting Rod Pin	2
11	9910-380080	Ring Pin	4
12	9910-160230	Piston Ring	2
14	9910-1040180	Retaining Washer	2
15	9910-580360	Diaphragm Bolt	2
16	9910-180150	Nut	2
18 ^{1,2,3}	9910-620030	O-Ring	4
19 ²	9910-1409050	Complete Valve Assembly	4
20	9910-111120	Retaining Ring	2
21	9910-620020	Cover	1
22 ³	9910-620210	O-Ring	1
23	9910-620291	Retaining Ring	1
24	9910-620190	Bearing	1
25	9910-850850	M6 X 30 Bolt	2
26	9910-550331	Washer	2
28 ³	9910-180101	O-Ring	2
29	9910-550030	Oil Sight Glass	1
30 ³	9910-550040	O-Ring	1
31	9910-550056	Oil Sight Glass Cap	1
32	9910-620160	Spacer	1
33	9910-550060	Roller Bearing	1
34	9910-620130	Seal	1
35	9910-620330	Retaining Ring	1
36	9910-620170	Crankshaft	1
37	9910-620150	Suction Manifold	1
38	9910-550340	Threaded Adapter	1
39 ³	9910-550350	O-Ring	2
40	9910-550242	Ring Nut	1
41	9910-550370	Hose Barb 1"	1
42 ³	9910-390060	O-Ring	4
44	9910-621780	M8 X 40 Bolt	8
45	9910-629211	Upper Air Chamber	1

Ref. No.	Part Number	Description	Qty.
46 ¹	9910-550190	Accumulator Diaphragm, Buna-N	1
47	9910-622070	Lower Air Chamber Body	1
49 ³	9910-650542	O-Ring	1
50	9910-180020	Air Valve	1
51 ³	9910-390290	O-Ring	1
52	9910-620680	Key (AP-A Model)	1
53	9910-620172	Thru-Shaft 20 mm Dia. "AP Version"	1
53	9910-620174	Thru-Shaft 3/4" Dia. "AP Version"	1
58	9910-620630	Seal	1
59	9910-620021	Cover	1
60	9910-650660	Diaphragm Holder	1
61	9910-650670	Suction Diaphragm	1
62	9910-650690	Clamp	1
63	9910-1500350	PTO Shield	1
64	9910-820670	M10 X 16 Bolt	4
65	9919-620190	Bearing	1
66	2406-0023	Drain Plug, oil	1
67 ³	9910-740290	O-Ring	1
68	9910-620930	Spacer	1
69	9910-620940	Spacer	1
70	9910-380230	Bearing	1
74	9910-390270	Nut	2
75	9910-450145	Flange	1
76	9910-110130	1/2" Fitting plus Hose Barb	1

¹ Denotes Diaphragm Kit 9910-KIT1724

² Denotes Valve Kit 9910-KIT1917

³ Denotes O-Ring Kit 9910-KIT1916

Ref. No.	Description	Tightening Torque	
		In. Lbs.	Nm
4	Bolt	393.7	44.1
15	Bolt	262.5	29.4
16	Nut	350.0	39.2
25	M6 x 30 Bolt	87.5	9.8
44	M8 x 40 Bolt	175.0	19.6
64	M10 x 16 Bolt	87.5	9.8
74	Nut	175.0	19.6



9910-KIT1724 Diaphragm Kit Desmopan	
Ref. No.	Qty.
5	2
18	4
46	1

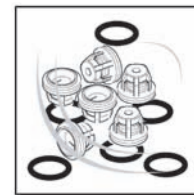

9910-KIT1917 Valve Kit	
Ref. No.	Qty.
18	4
19	4

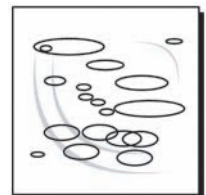

9910-KIT1916 O-Ring Kit	
Ref. No.	Qty.
18	4
22	1
28	2
30	1
39	2
42	4
49	1
51	1
67	1