

Revised 10-1-2005

PENTA-B 40/280

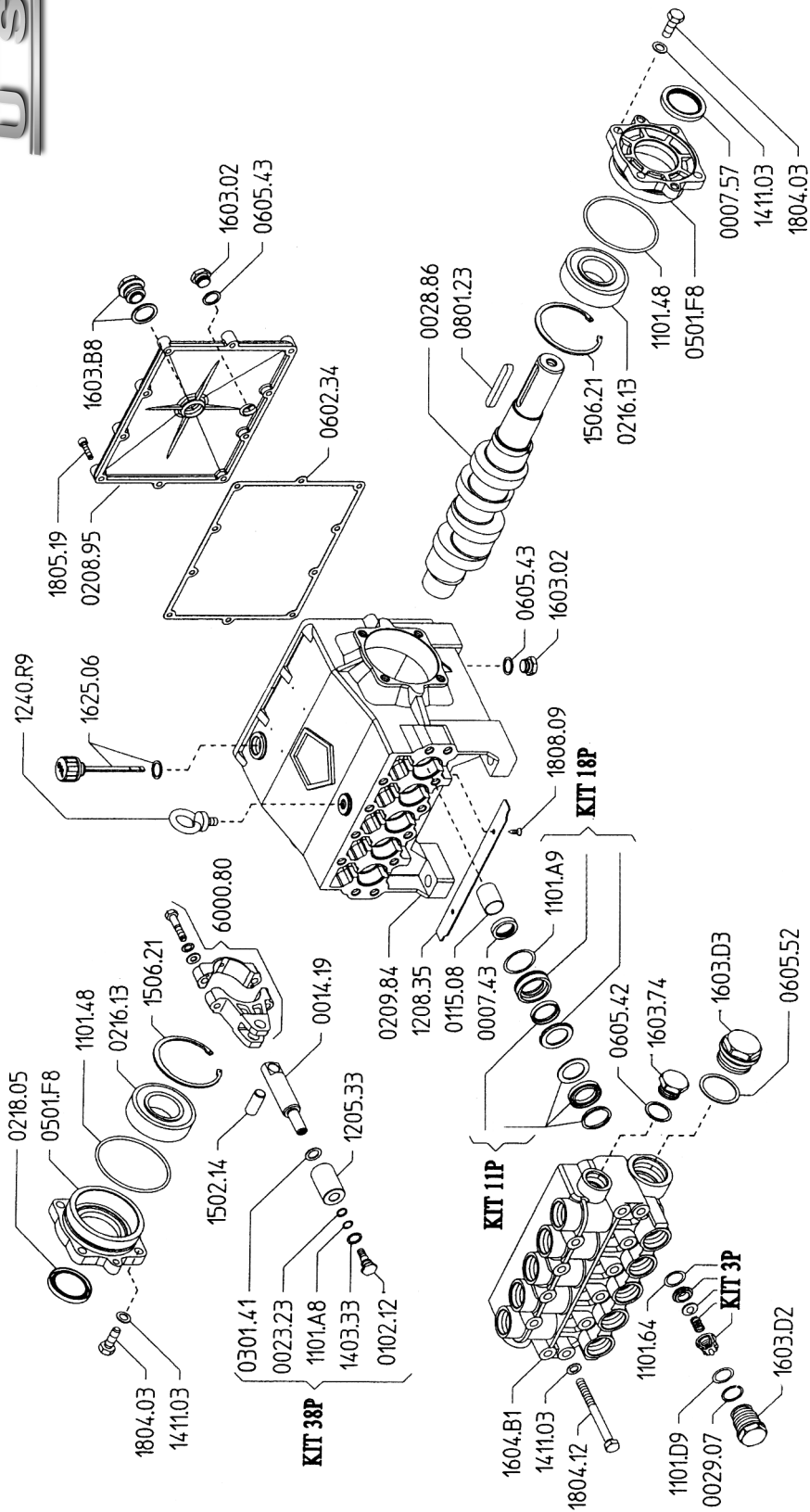

PENTA-B 40/280 Quick Reference

Maximum Flow	10 GPM	Valve Kit.....	04-KIT UD-3P
Maximum Pressure	4000 PSI	Seal Kit	04-KIT UD-11P
Rated Pump Speed	1000 RPM	Brass Kit	04-KIT UD-18P
Oil Capacity.....	80 oz. UDOR LUBE or SAE 30W	Plunger Bolt Kit.....	04-KIT UD-38P
	Non-Detergent Oil	Plunger Part #	04-1205.33
		Plunger Diameter.....	25 MM

PENTA-B 40/280